

# SH 130-C012

## Interactive Counterbalance Monitor Arm

Fits most 17"-32" Flat & Curved LCD/LED Monitors



Create space on the desktop and provide a more flexible and productive workspace.

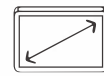
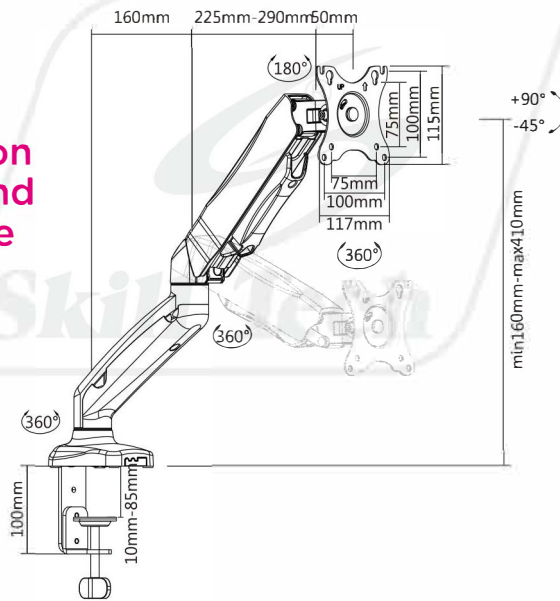

Screen Size  
**17"-32"**



Weight Capacity  
**2-6.5kg  
4.4-14.3lbs**



Tilt Range  
**+90° ~ -45°**

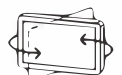

Swivel Range  
**+90° ~ -90°**

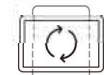

Screen Rotation  
**360°**

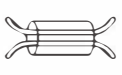

Cable Management

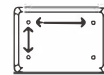

VESA Compatible  
**75x75 100x100**



Curved Monitor

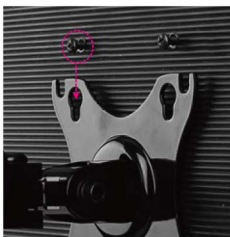

**Pear-shaped VESA Slot** makes the installation much easier by one-step slide-in.



**Gas Spring Counterbalance** floats the monitor with a light touch for a customized placement to match your viewing needs anytime.



**Built-in Spring Gauge** can be adjusted to suit various monitor weight.



**Cable Management** routes cables under the arm to reduce clutter for a clean look.



**2.0 USB Port and Audio Port in the Basement** are convenient for supporting data transfer, charging and sound input/output.



**Grommet/Desk Mount Base** suits most desks with adjustable clamp height.